

Scalable, Interpretable QNLP

An implementation on trapped ions

Tiffany Duneau

Quantinuum, University of Oxford

QDisCoCirc Team



Bob Coecke



Anna Pearson



Gabriel Matos



Tiffany Duneau



UNIVERSITY OF
OXFORD



Saskia Bruhn



Konstantinos Mei

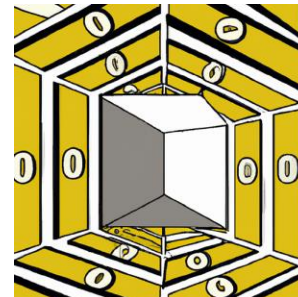

Tuomas Laakkonen



Katerina Saiti



Universiteit
Leiden



Alice walks north.
Bob walks south.
Bob follows Alice.
⋮

Is Bob going in the same
direction as Alice?



Compositional Model

DisCoCirc

arXiv: 2301.10595

DisCoCirc

Alice walks north.
Bob walks south.
Bob follows Alice.
⋮

Is Bob going in the same
direction as Alice?

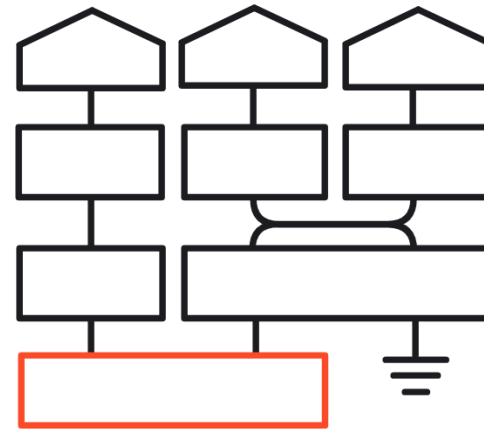

We convert *sentences* into DisCoCirc *diagrams*.

The *sentences* with shared *nouns* compose sequentially.

Unrelated *phrases* are separated.

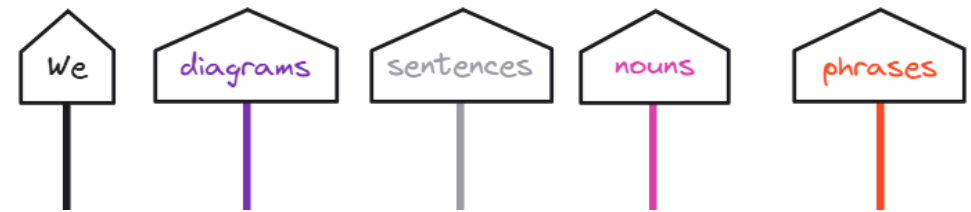

We convert sentences into **DisCoCirc** diagrams.

The sentences with **shared** nouns **compose** sequentially.

Unrelated phrases are **separated**.

Adjectives

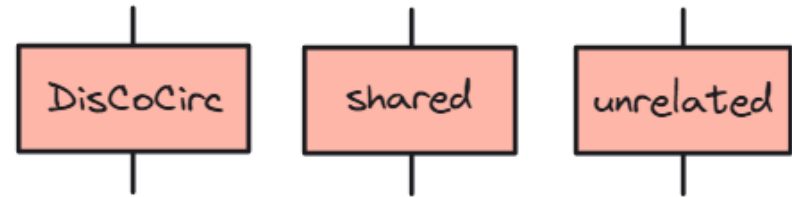

Intransitive verbs

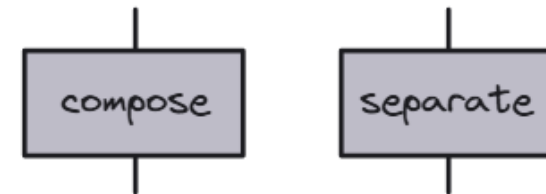

We **convert** sentences **into** DisCoCirc diagrams.

The sentences **with** shared nouns compose **sequentially**.

Unrelated phrases are separated.

Prepositions

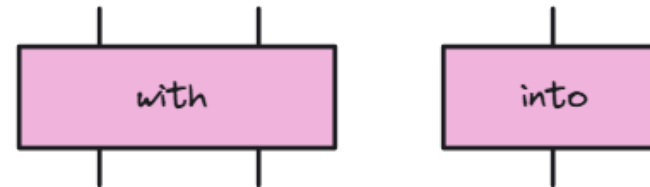

Higher-order

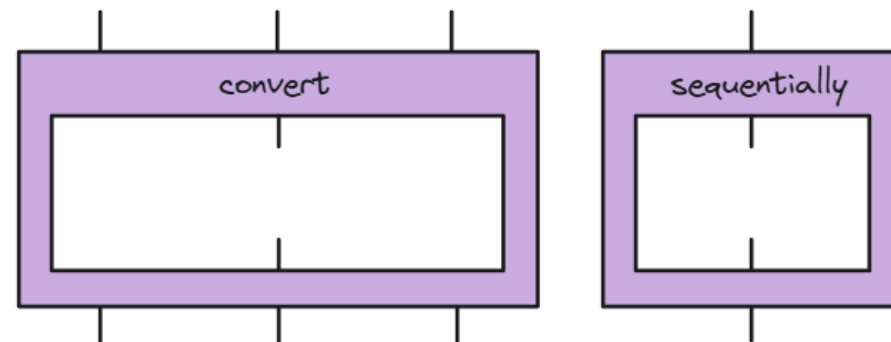

We convert sentences into DisCoCirc diagrams.

The sentences with shared nouns compose sequentially.

Unrelated phrases are separated.

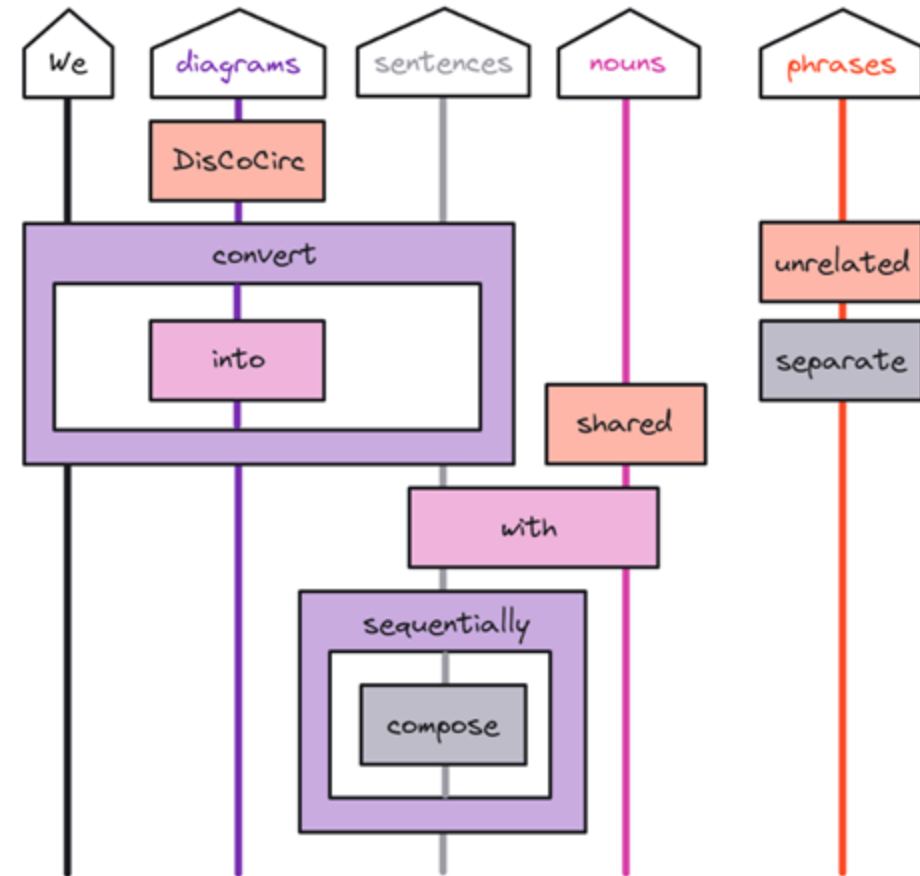

We convert sentences into DisCoCirc diagrams.

The sentences with shared nouns compose sequentially.

Unrelated phrases are separated.

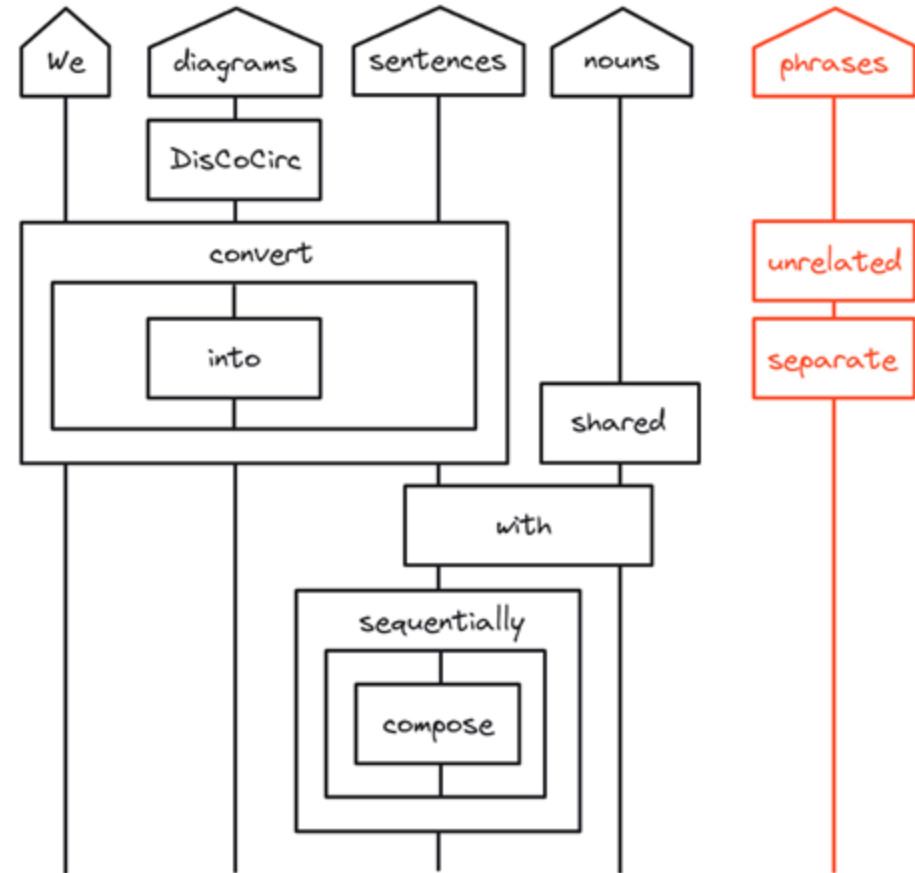

Quantum DisCoCirc

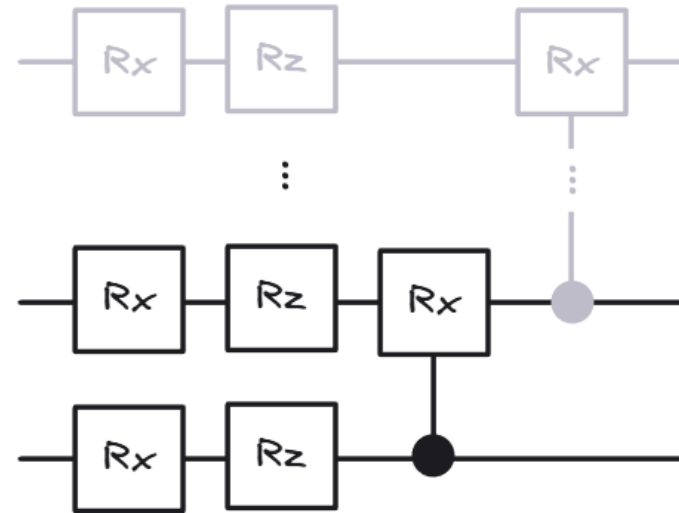
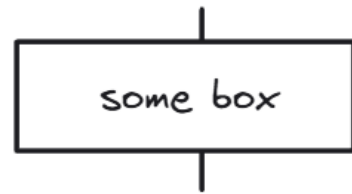



Task

“Following” Dataset



Alice



Bob



...



2
directions



Alice walks south
north
east
west



Alice turns around
left
right

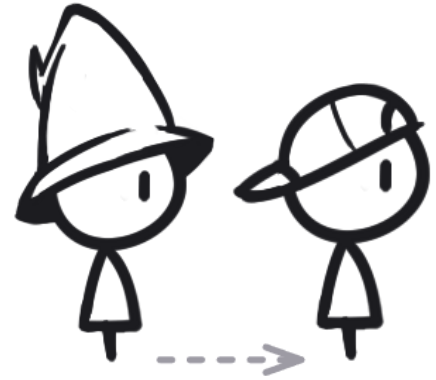

Alice follows Bob.
goes in
the opposite
direction of

4
directions

Productivity

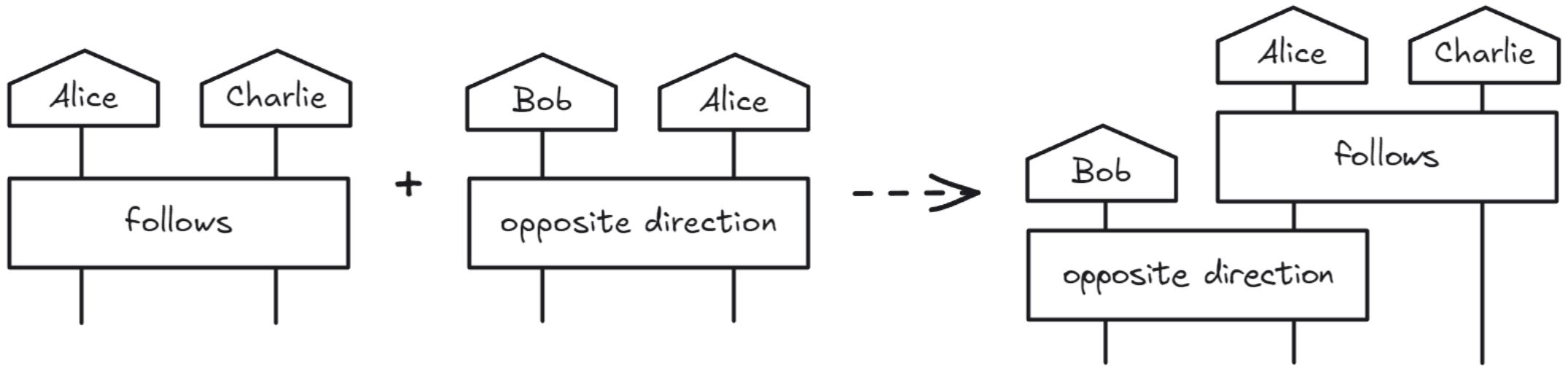

Dataset Split

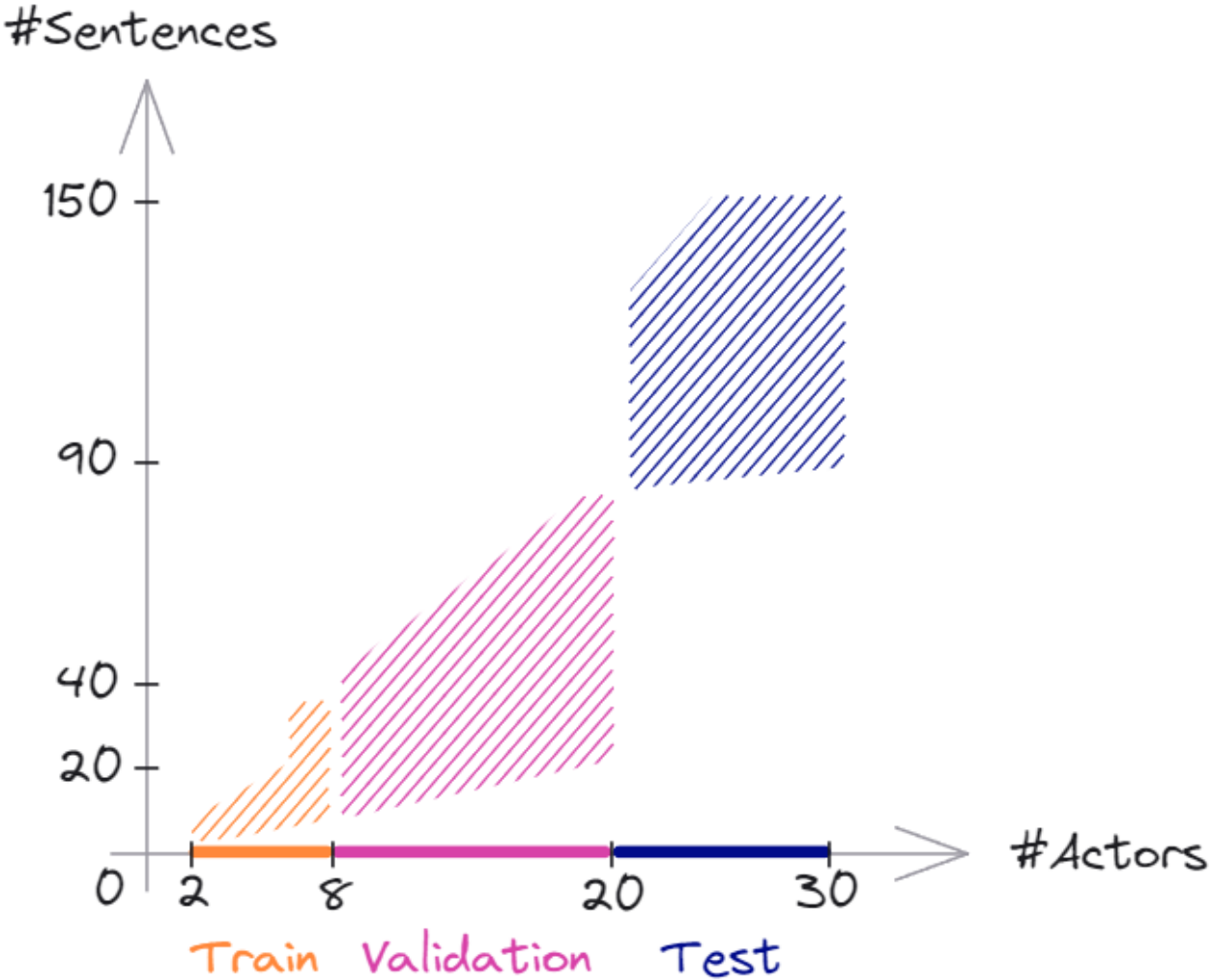

Pipeline

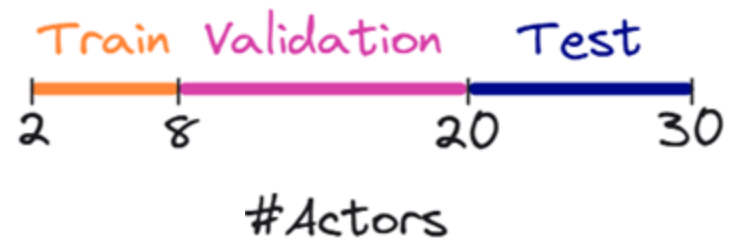

Pipeline

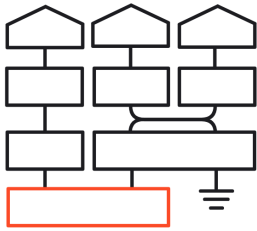

 Tensor
Network

 PyTorch



Pipeline

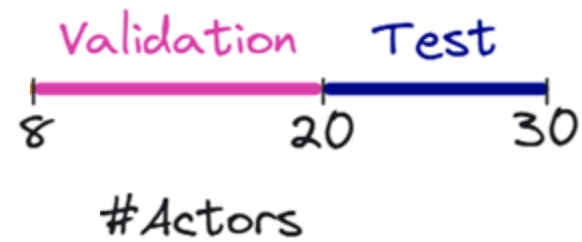
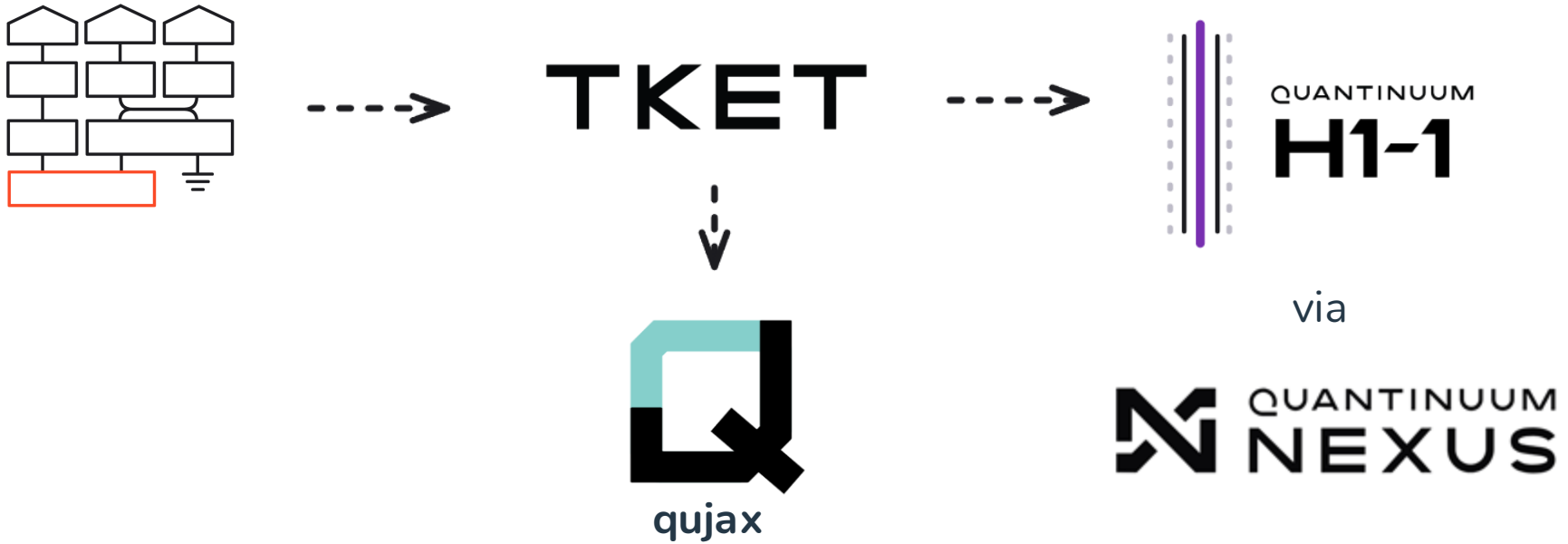

Compositional Generalisation

“train small, test big”

2

directions



Compositional generalisation

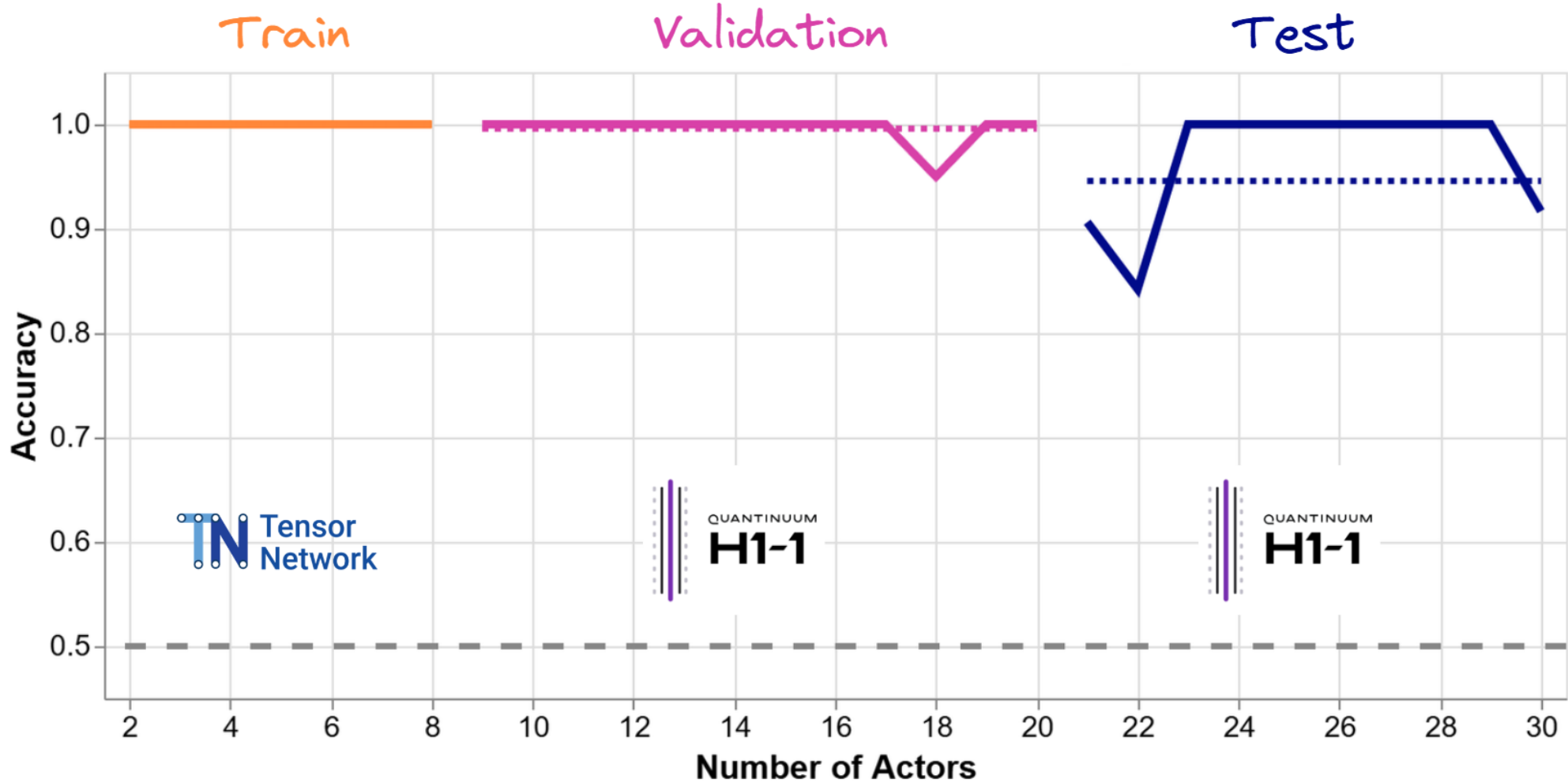

2

directions



Compositional generalisation

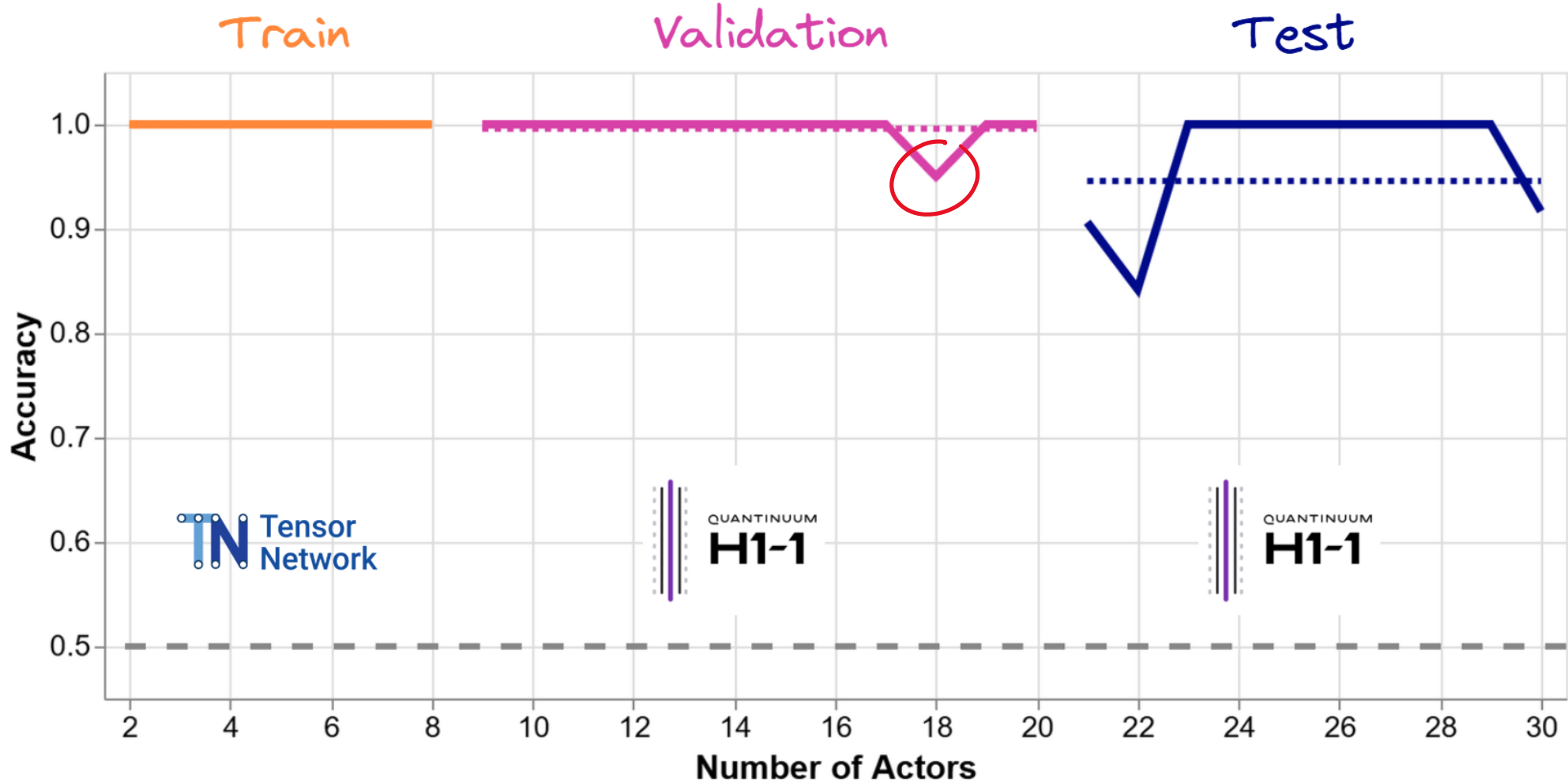

2 directions



Noise Simulations on Validation dataset

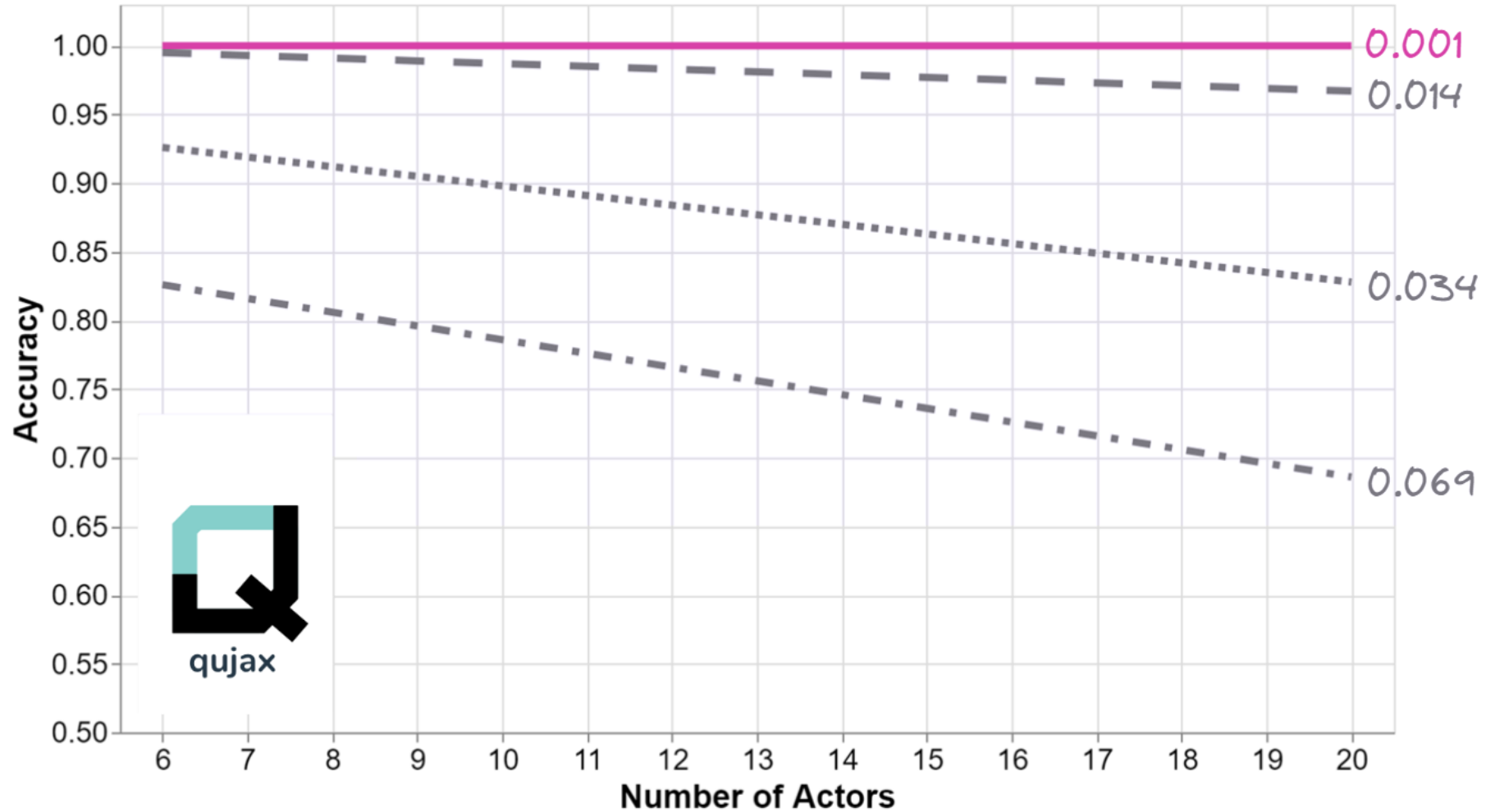

4

direction:



Compositional generalisation

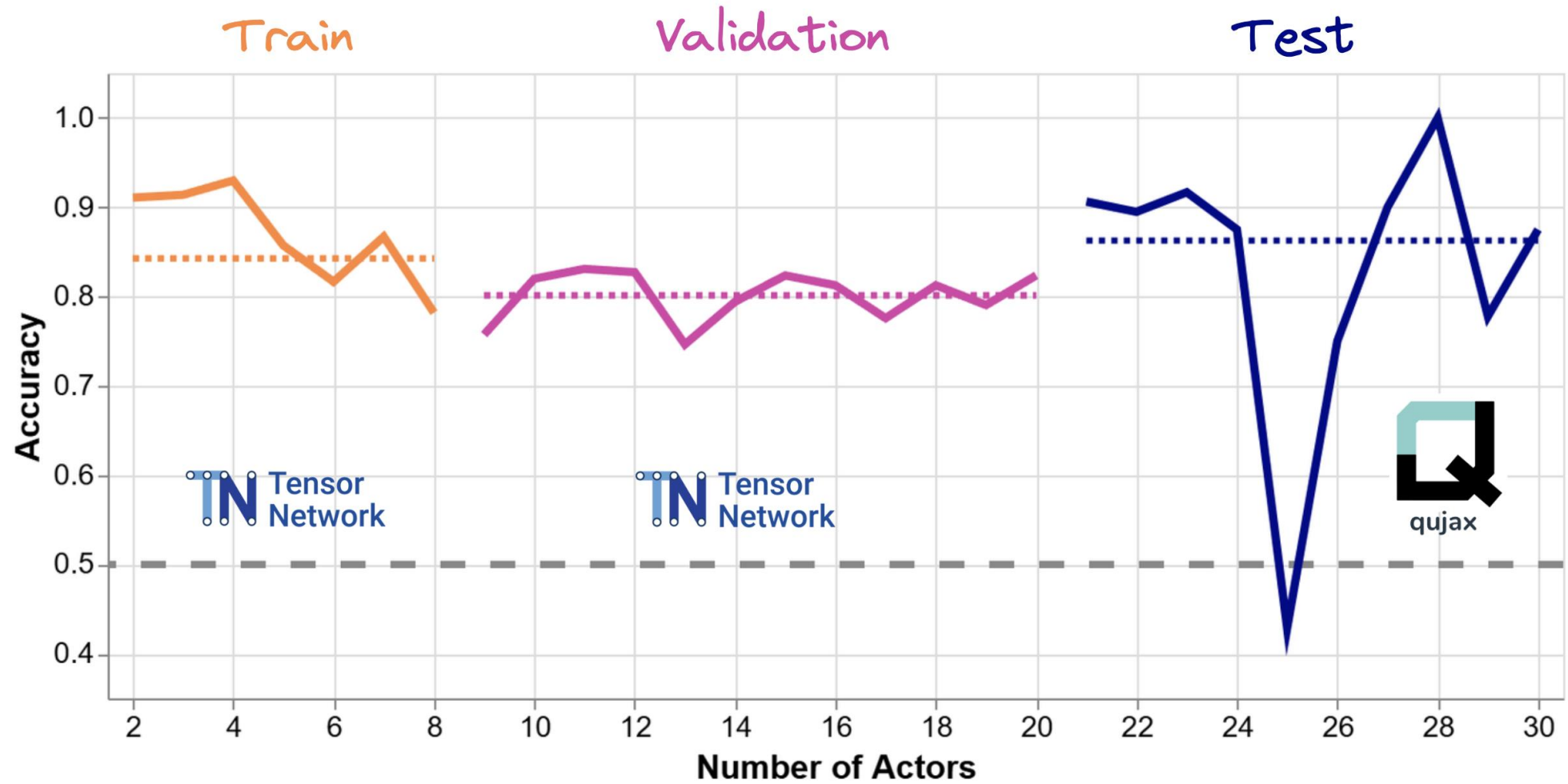

4

directions



Compositional generalisation

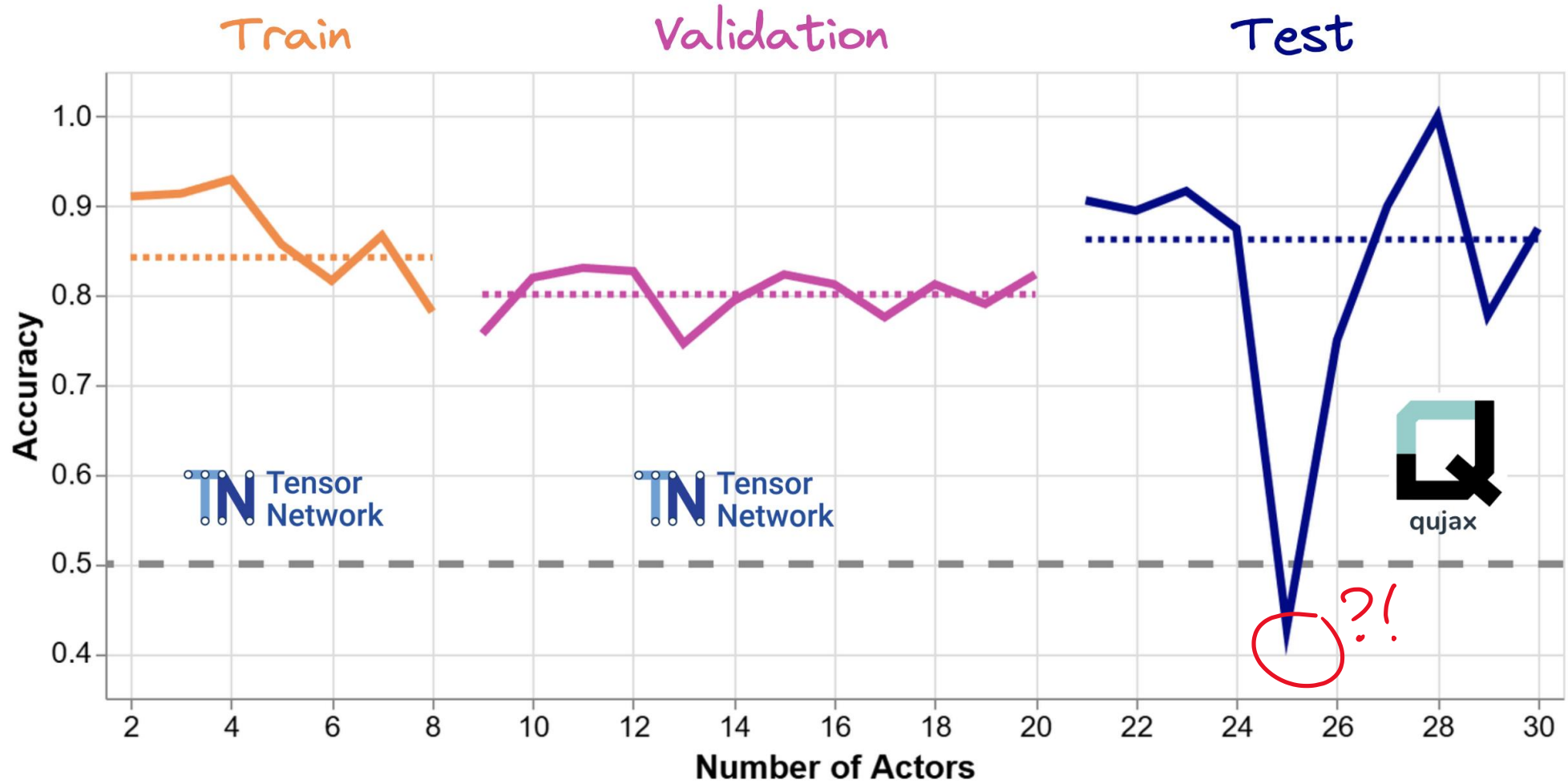



Compositional Interpretability



Black Box

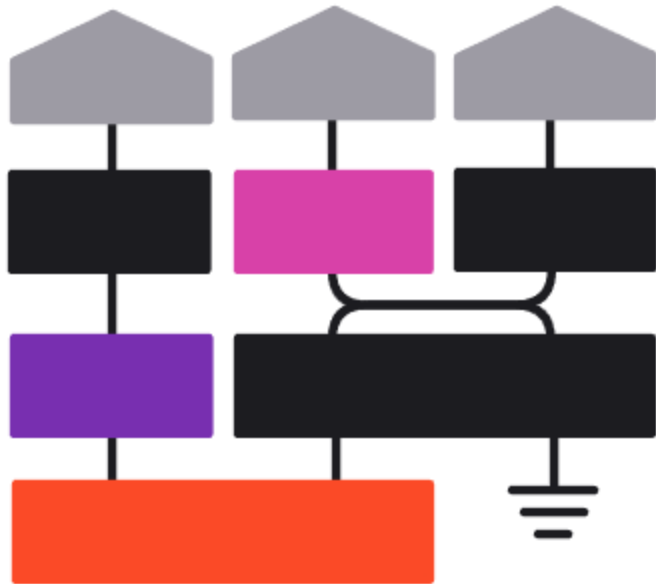

Many Black Boxes

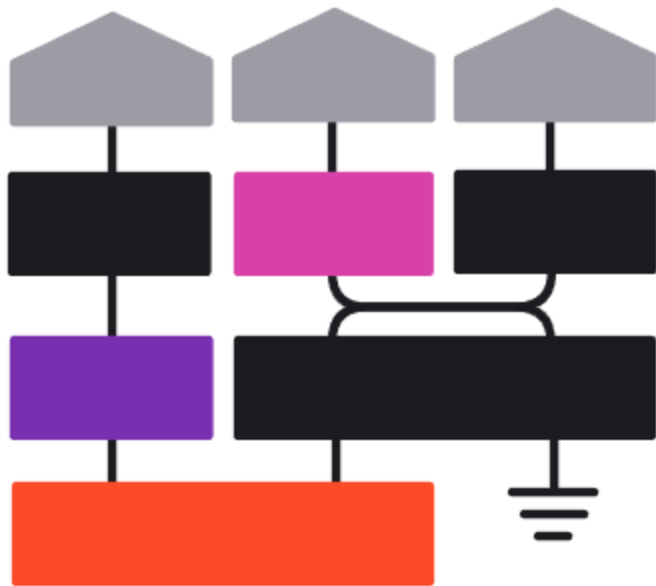

Many Black Boxes

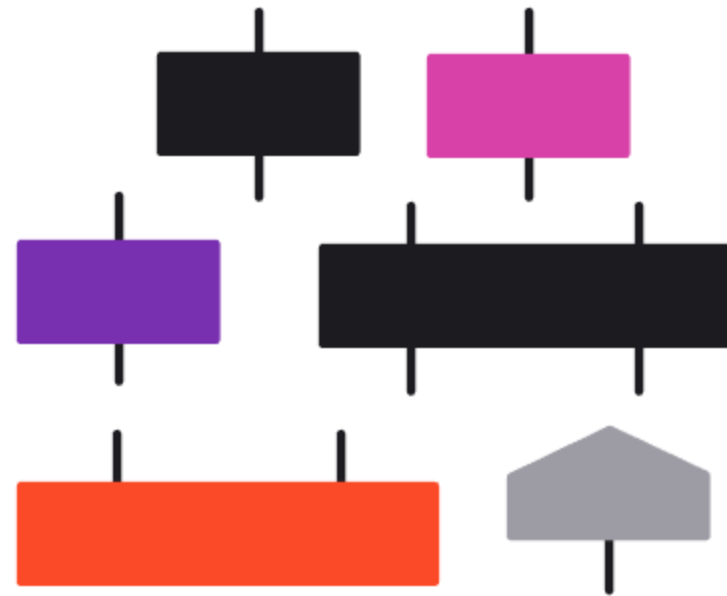

...decomposed!

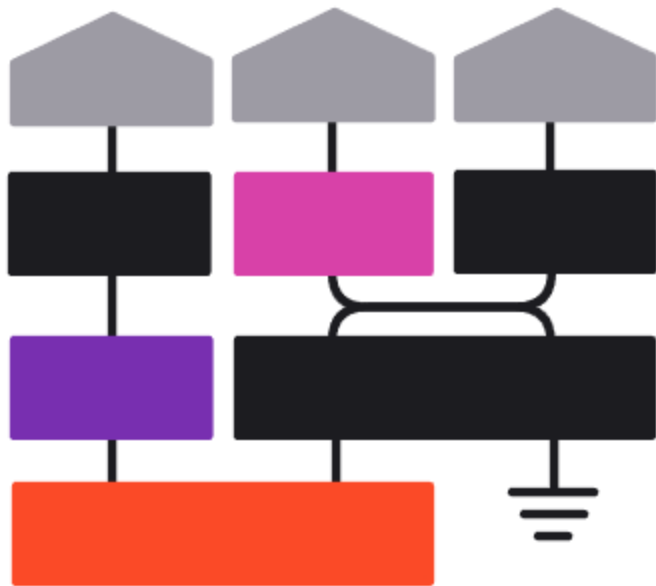

Many Black Boxes

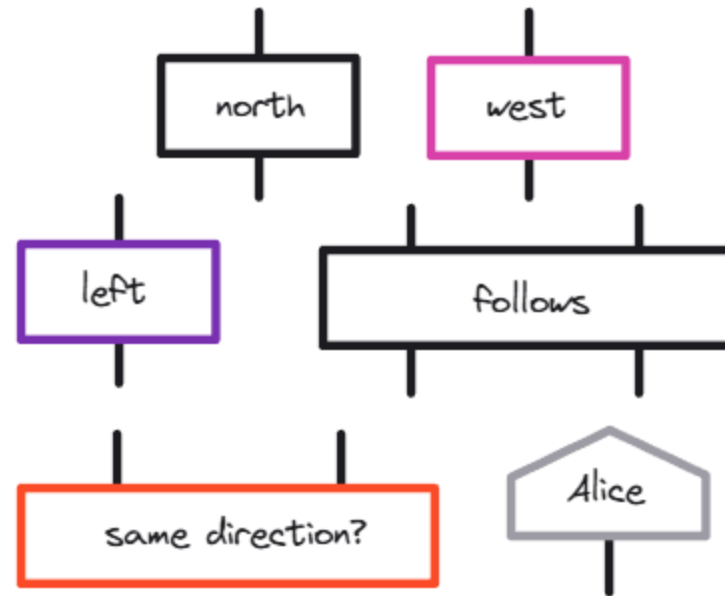

...decomposed!

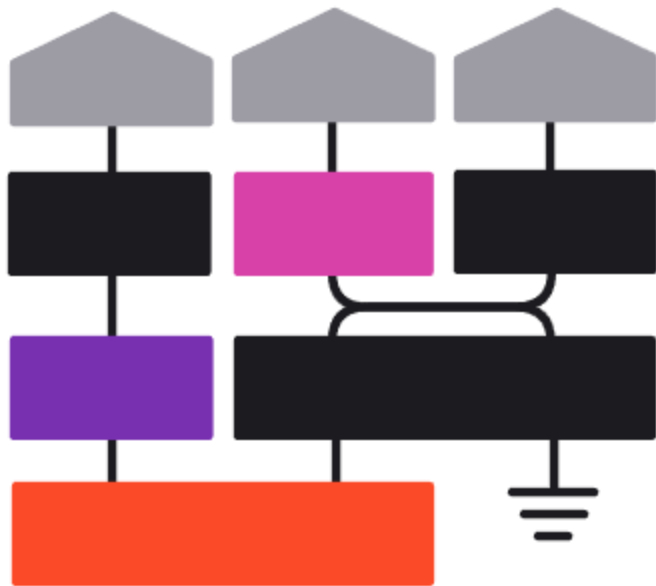

Many Black Boxes

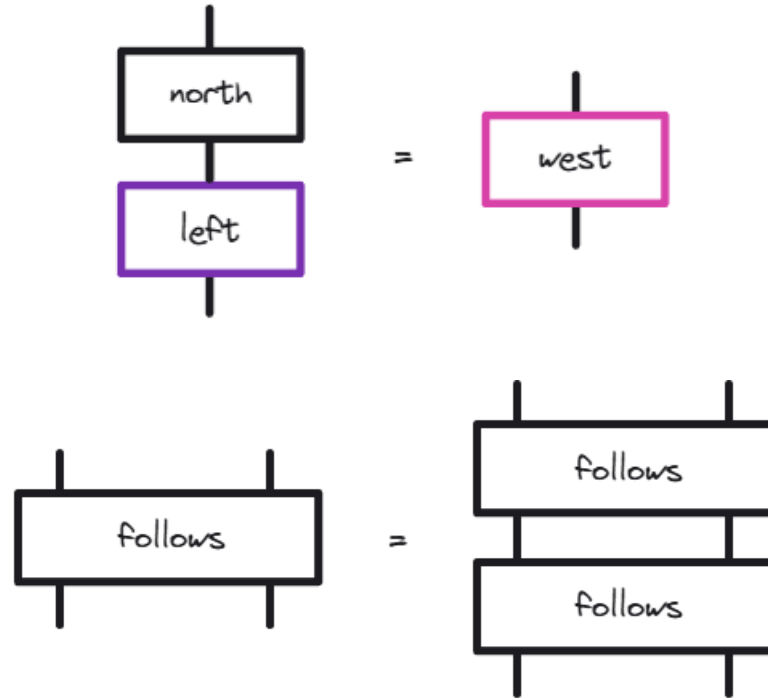

...recomposed!

2
directions

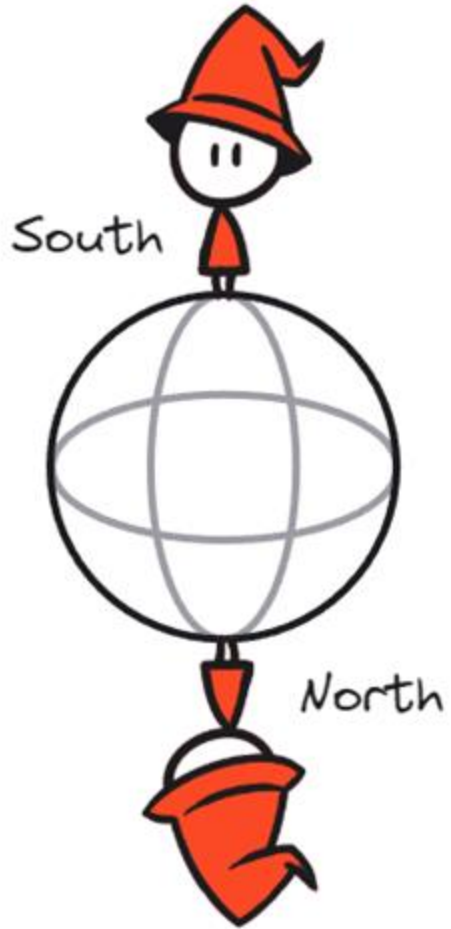

4
directions

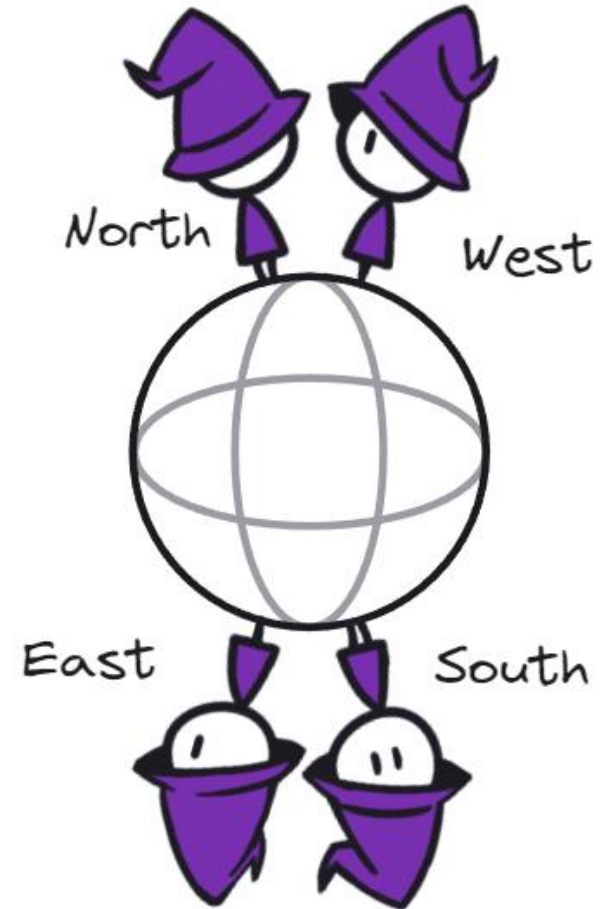

4

directions



Compositional generalisation

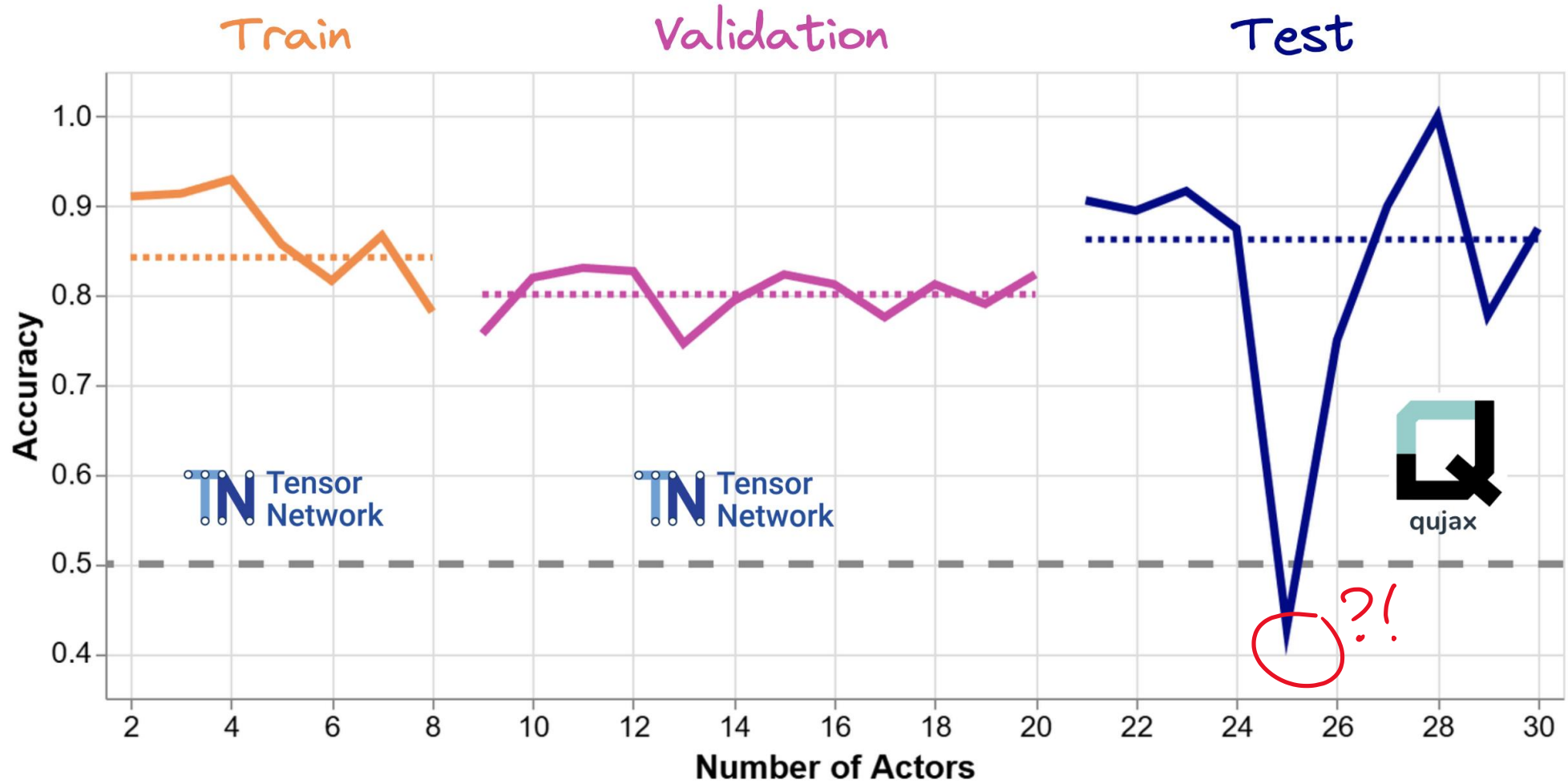



Classical Baselines

Accuracy Summaries

Two Directions

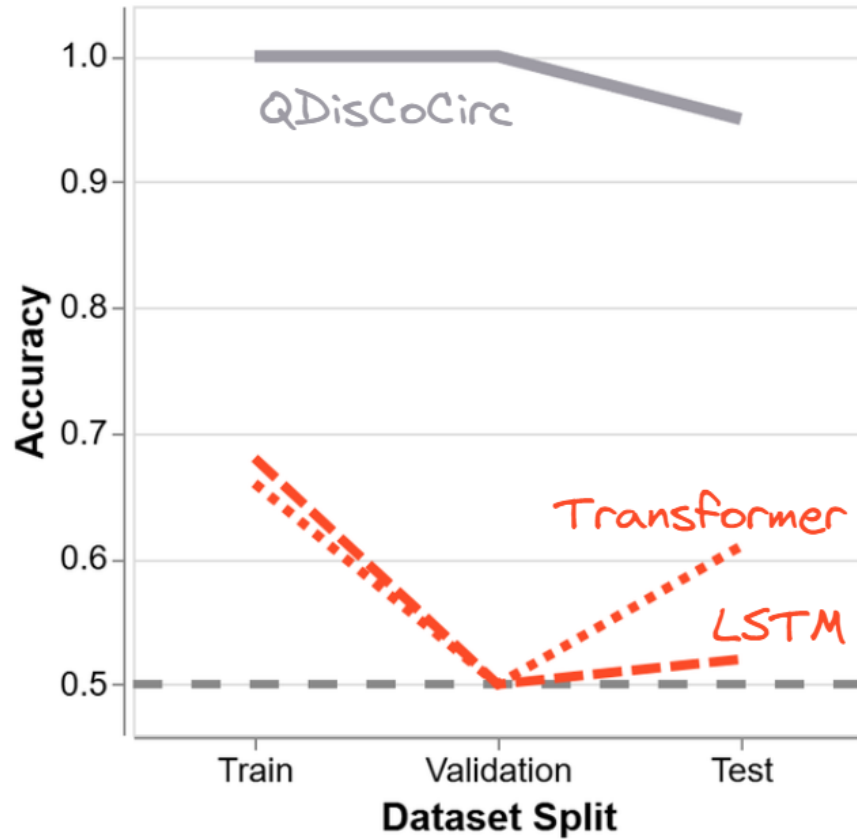

Four Directions

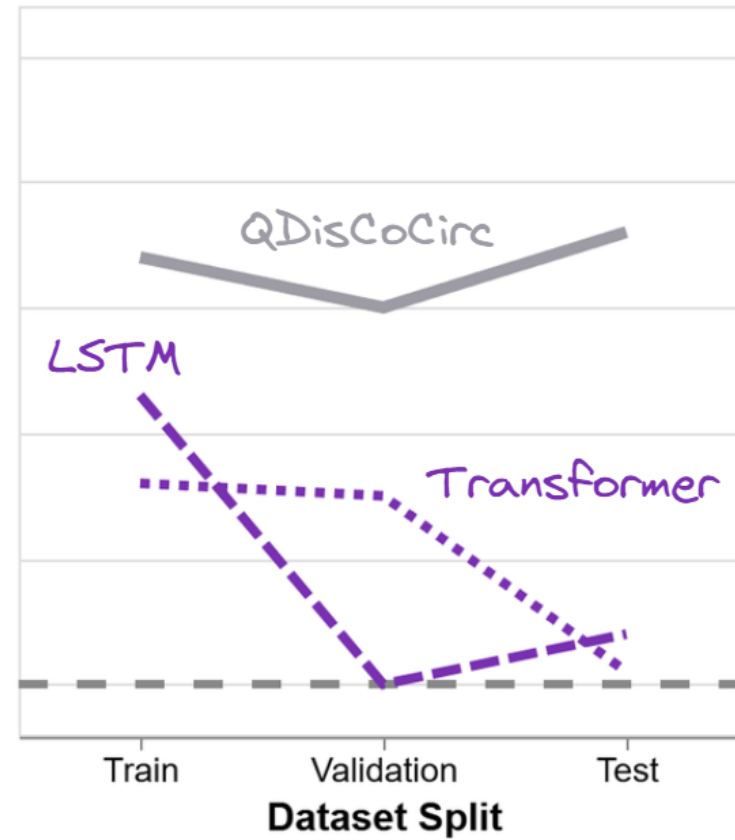

2
directions

4
directions

GPT-4

2
directions

4
directions

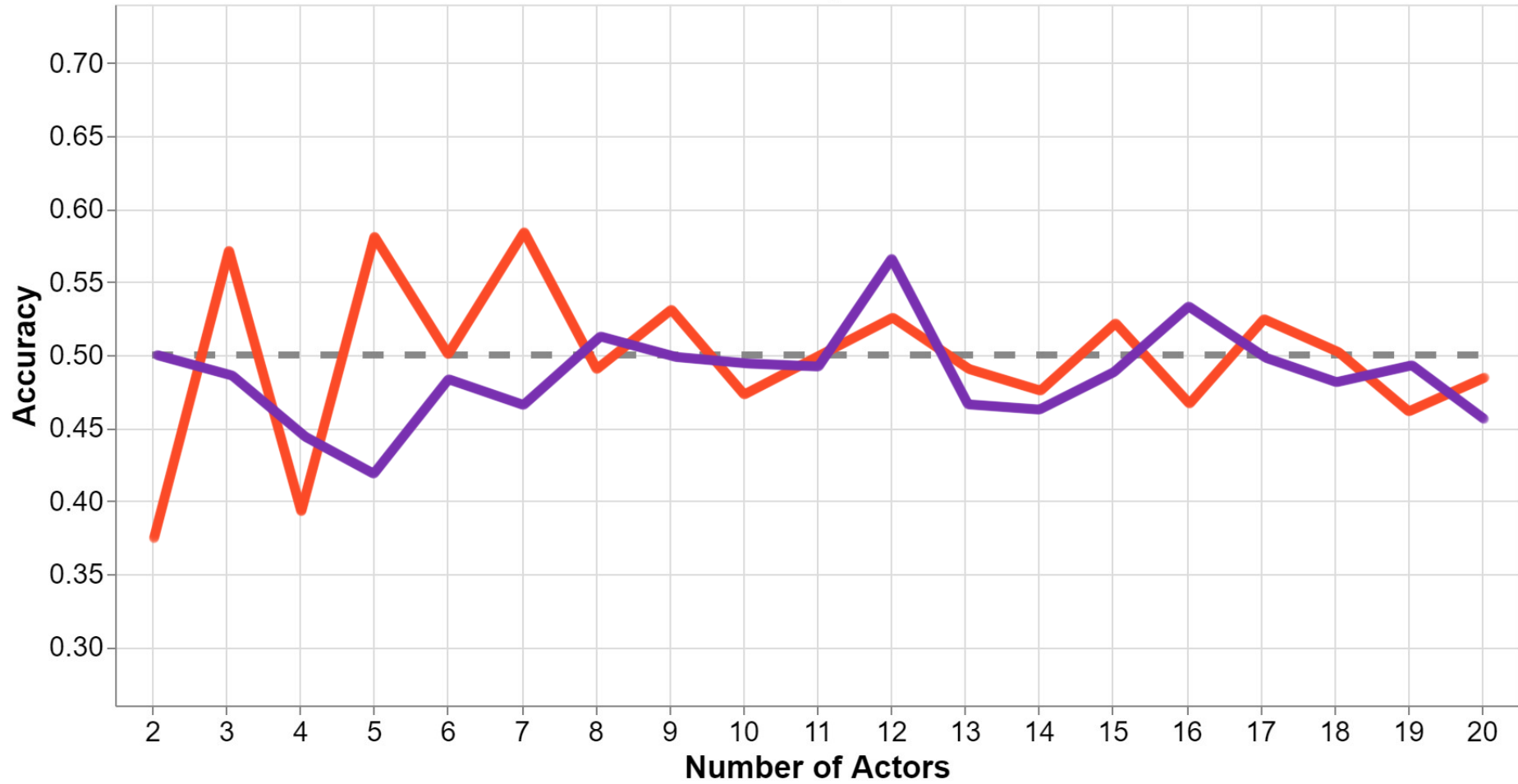

Accessed on 25th April 2024.

Summary

Compositional...

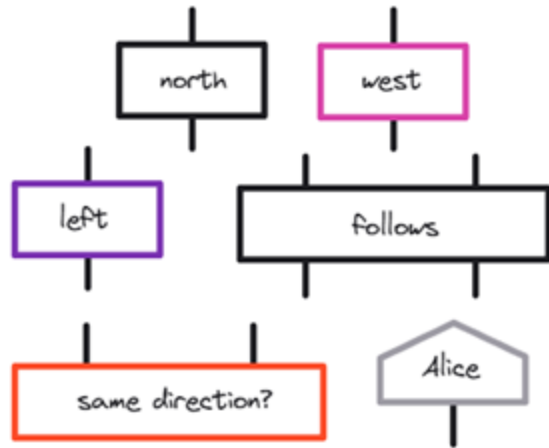

Model

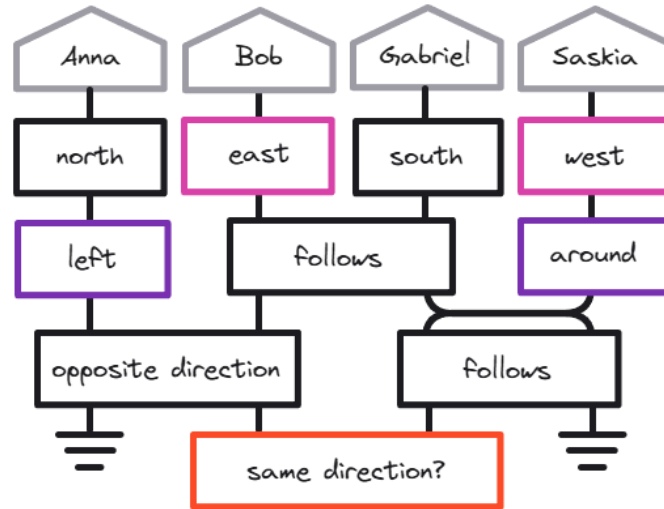

Generalisation

+

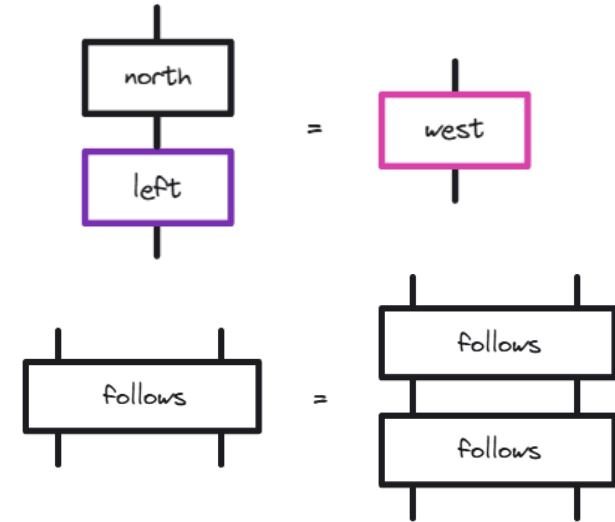

Interpretability



LAMBEQ

Natural Language Processing on
Quantum Computers

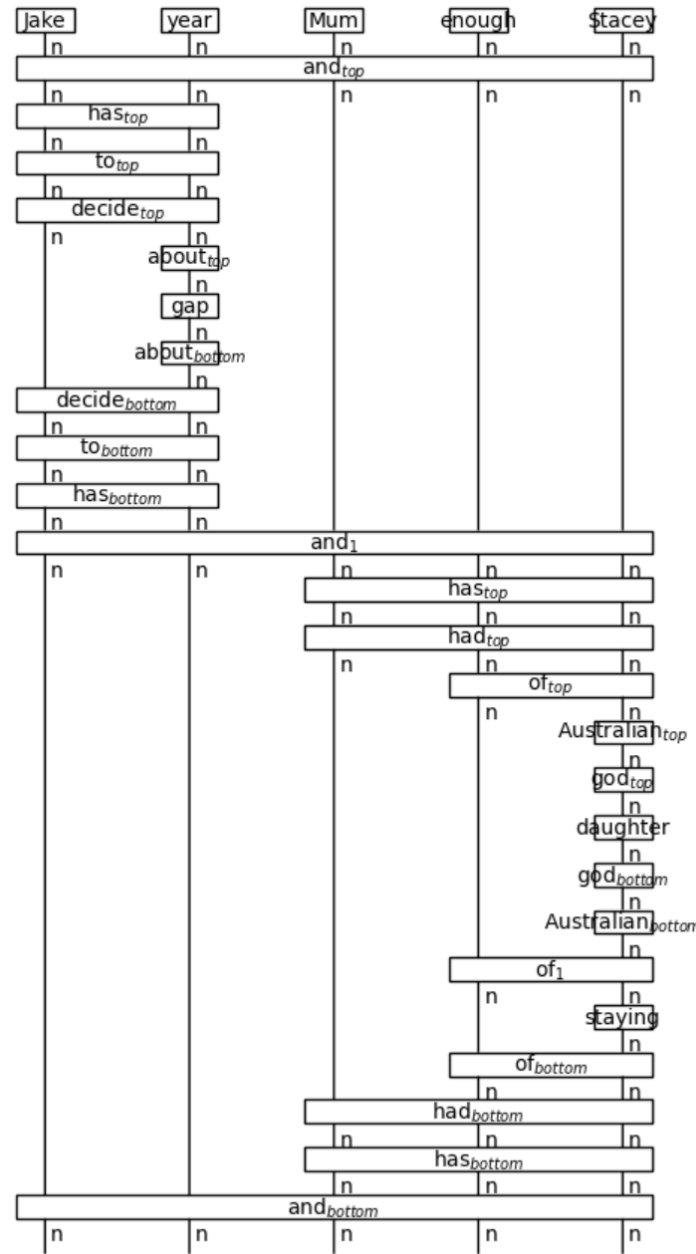
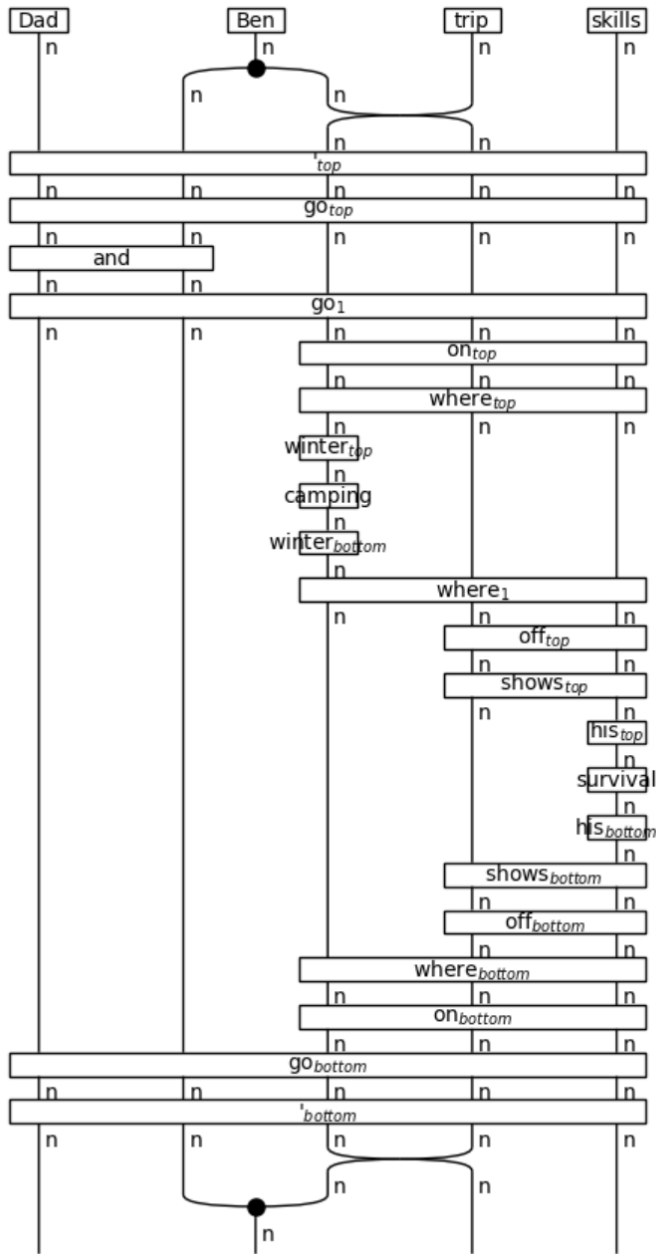

Real Data

“Dad and Ben go on a winter camping trip, where Ben shows off his survival skills. Jake has to decide about a gap year, and Mum has had enough of Australian god-daughter Stacey staying.”

- BBC Synopsis Dataset

Try it yourself!

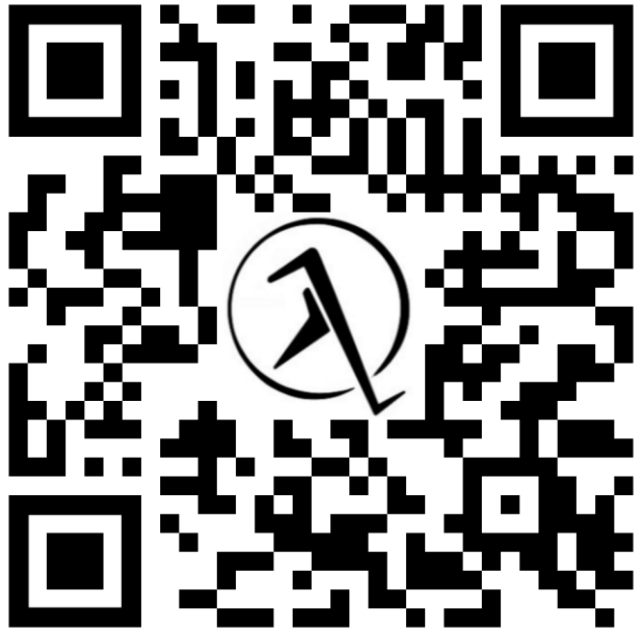

```
> pip install lambeq
```

DisCoCirc

2301.10595

Interpretability

2406.17583

I. Theory

2408.06061

II. Experiment

2409.08777

Blog post

<https://www.quantinuum.com/blog/talking-quantum-circuits>

